



反対側にもあります。
Repeat for opposite side.
Wiederholung für gegenüberliegende Seite.
Répétition de la page précédente.
También en el lado opuesto.
另一邊同樣零件。
반대쪽도 포함합니다.

×2

2組つくります。
Make 2sets.
2 Sätze erstellen.
Realizar deux pieces.
Ensamble dos juegos.
同樣的製作2套。
2번 조립합니다.



どちらかを省きます。
Optional parts.
Teils nach Wahl.
Pièces au choix.
Seleccione uno.
可以選擇使用。
선택 부품을입니다.



切り取ります。
Remove.
Beschneiden.
Découper.
Corte.
비트
잘라냅니다.

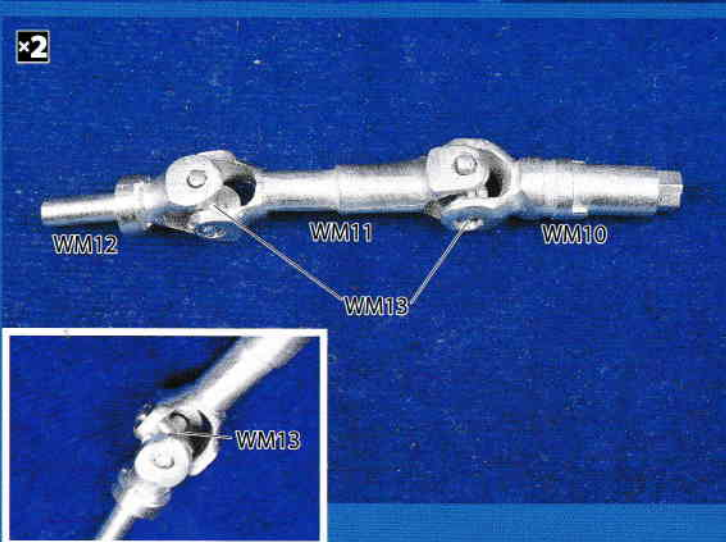
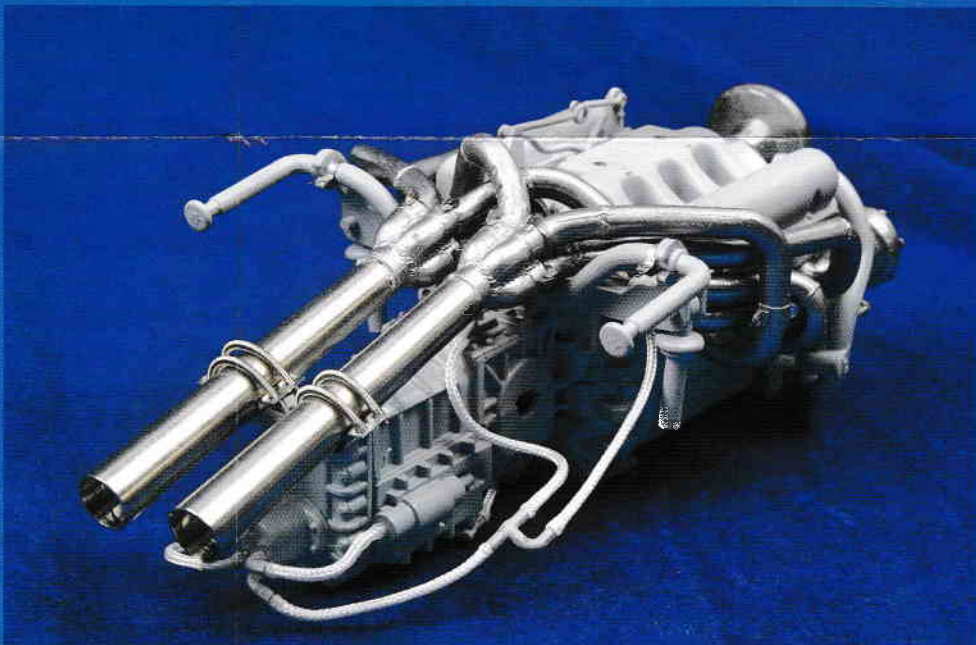
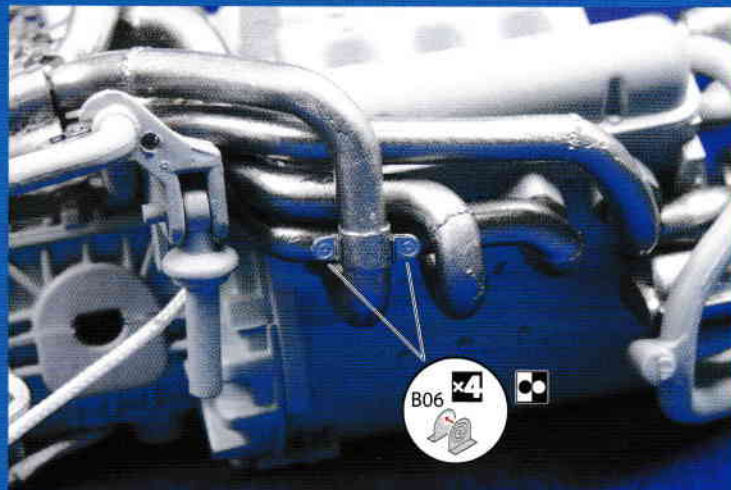
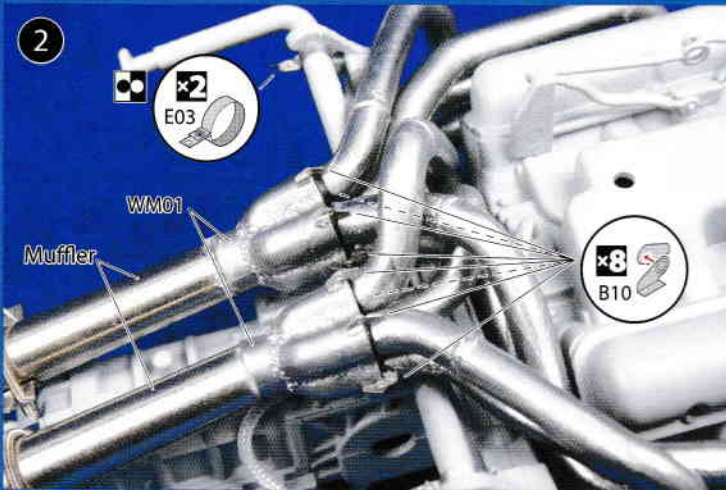
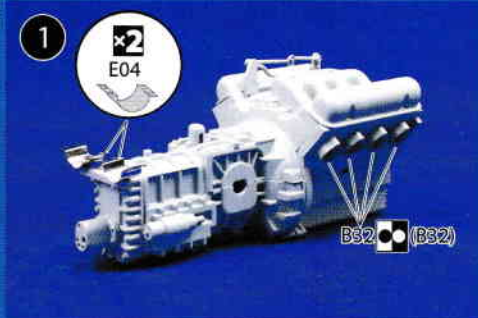

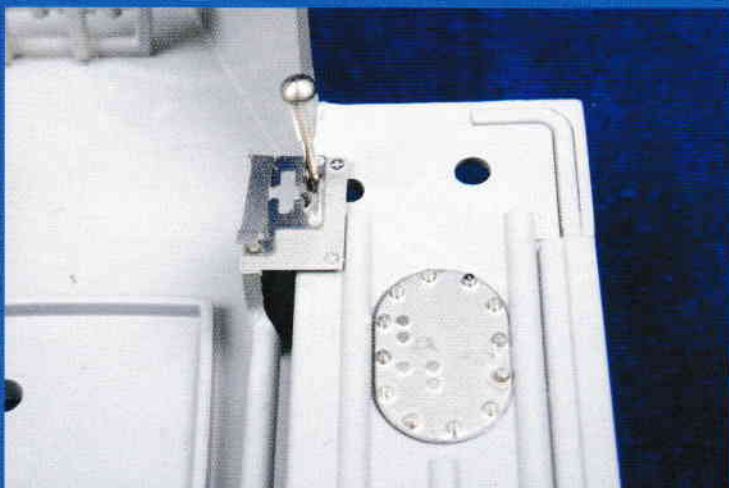
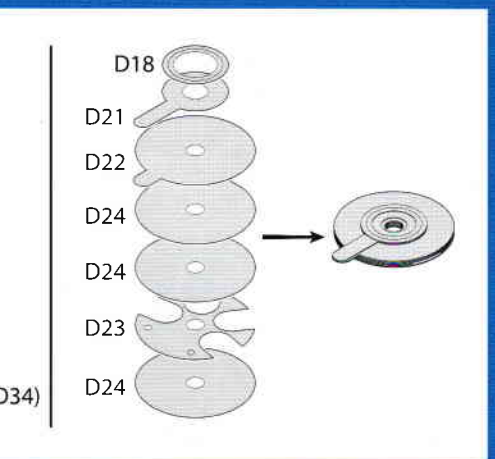
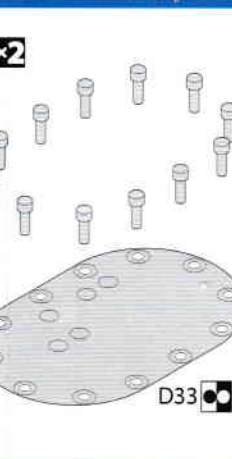
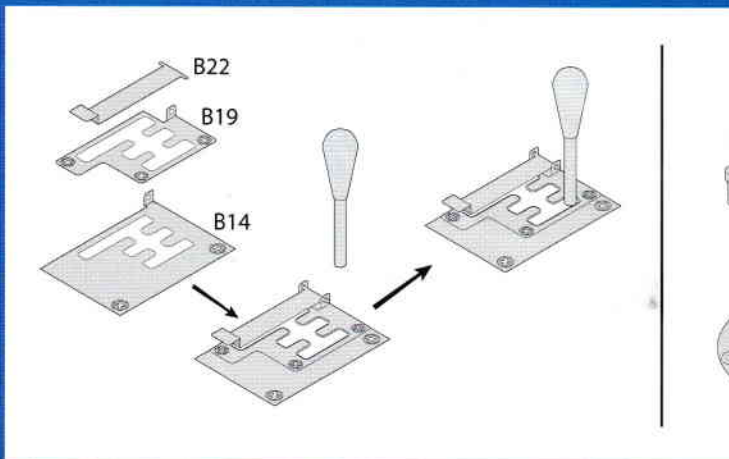
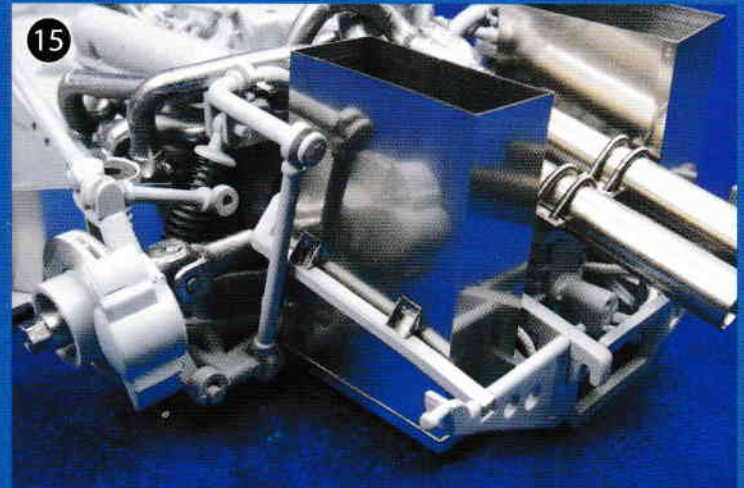
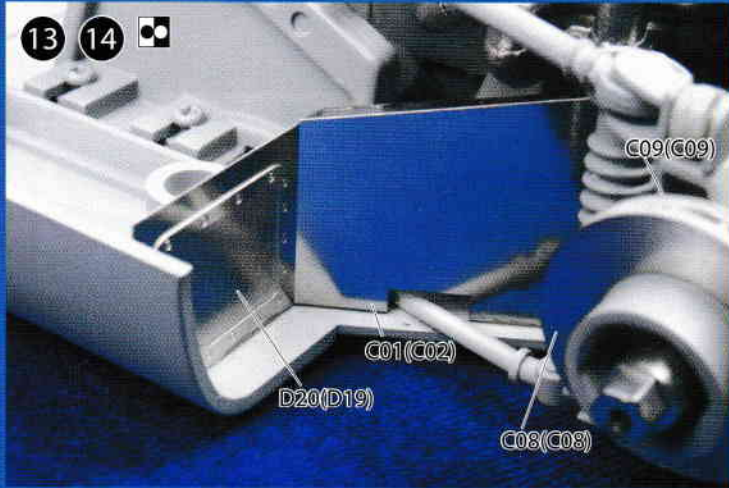
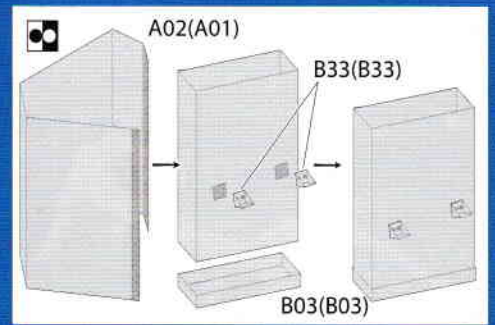

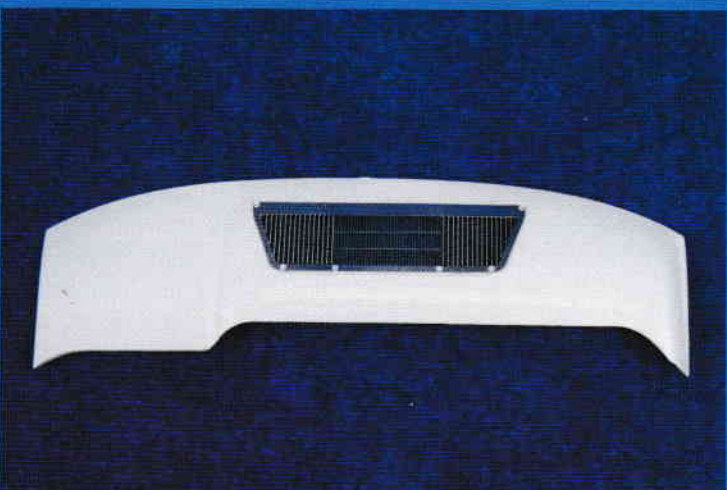
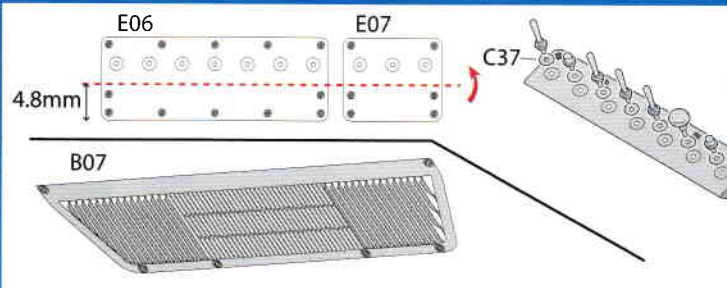
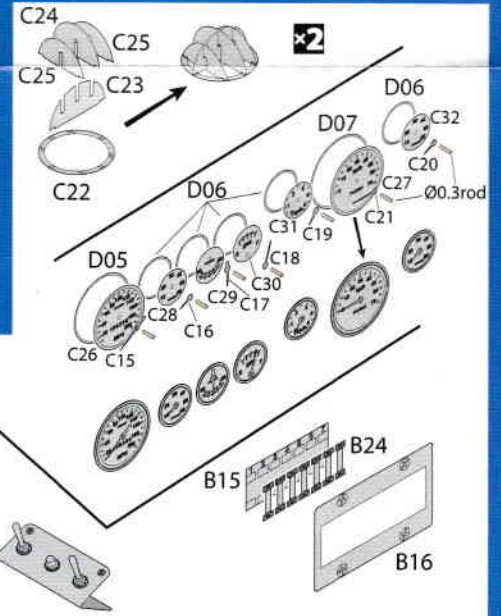
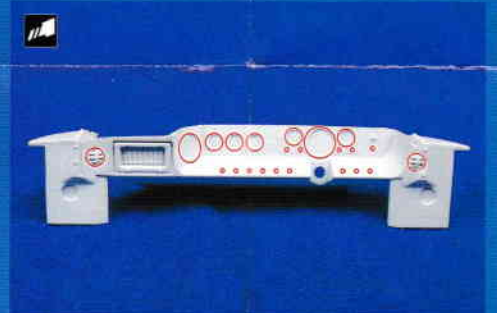
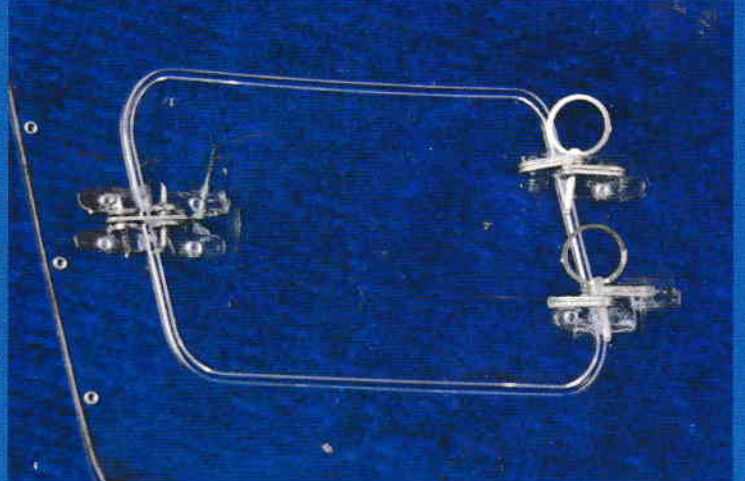
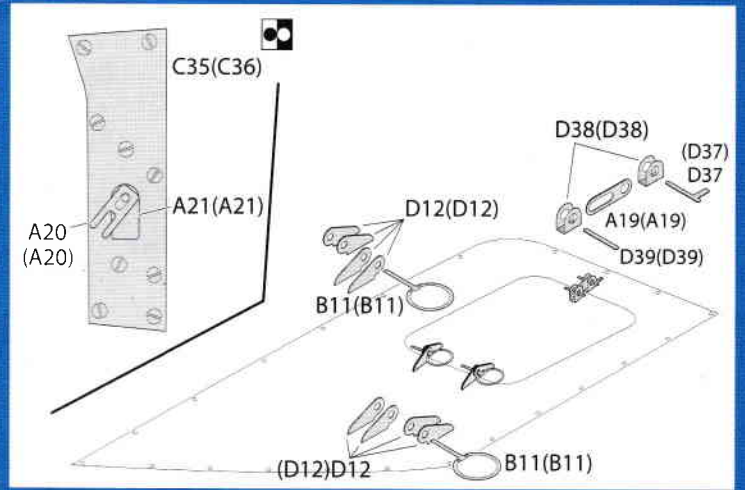
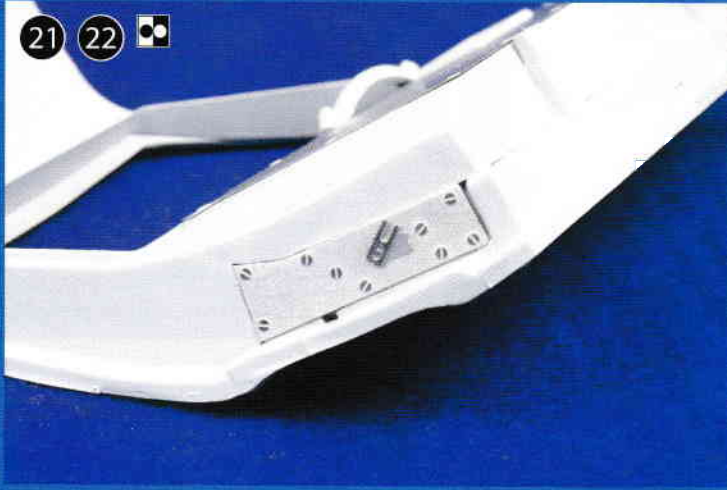

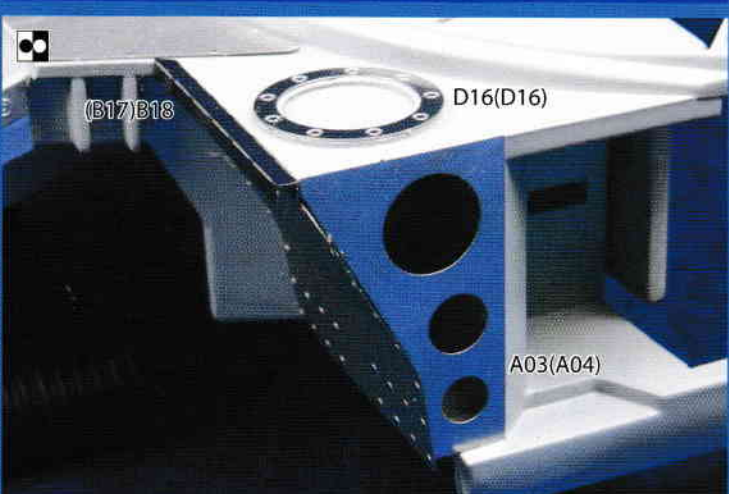
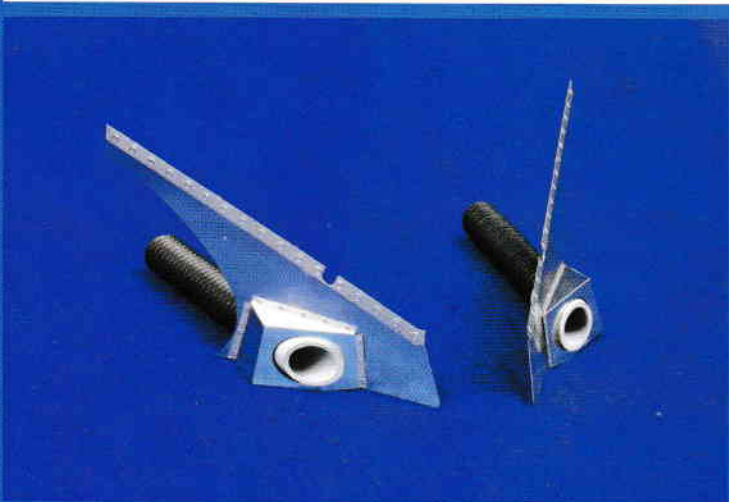
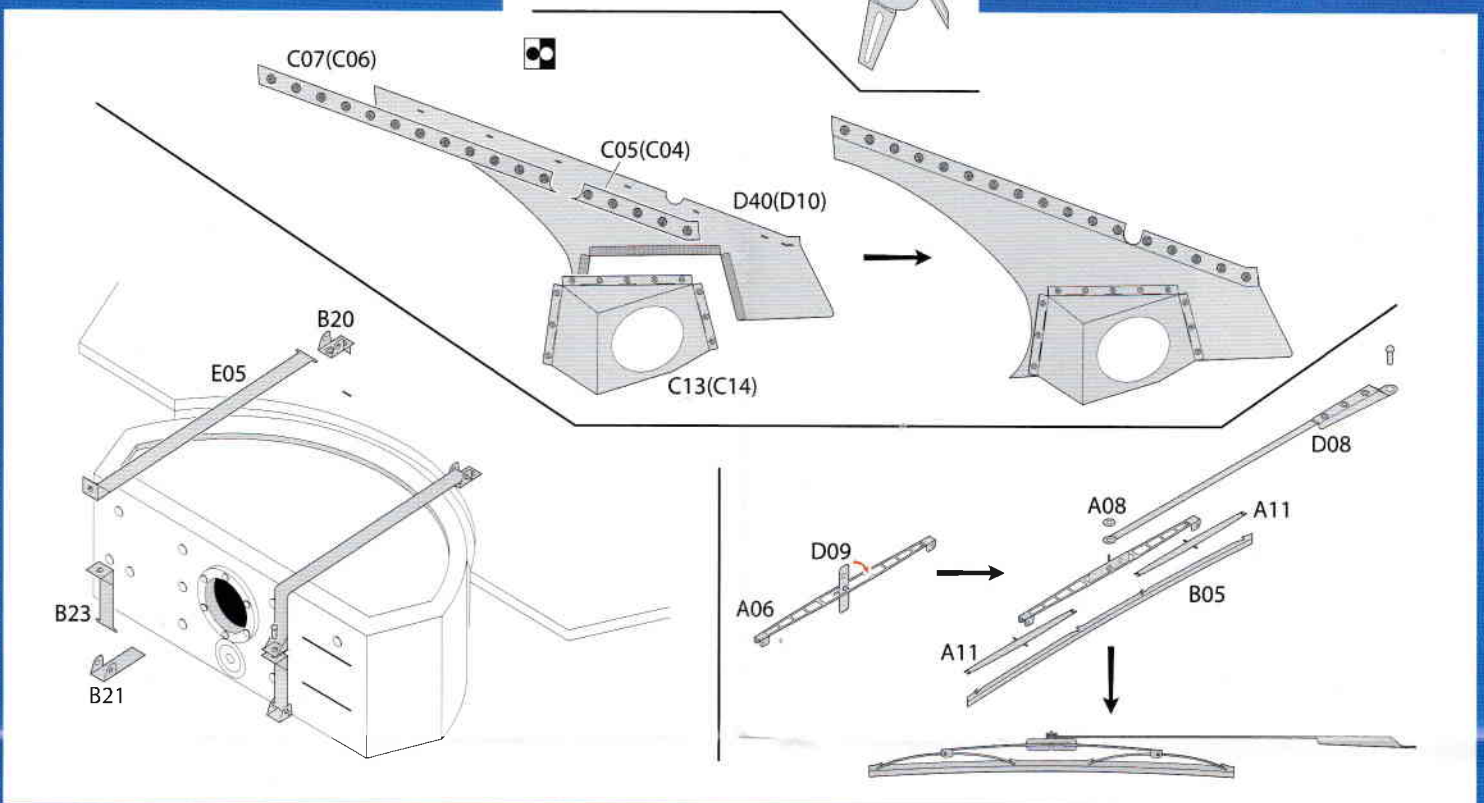
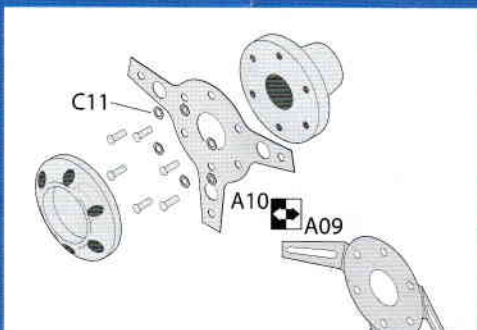
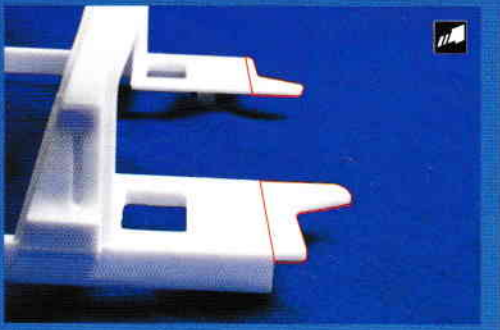

26



B02



B01

A13



B25

E02

33

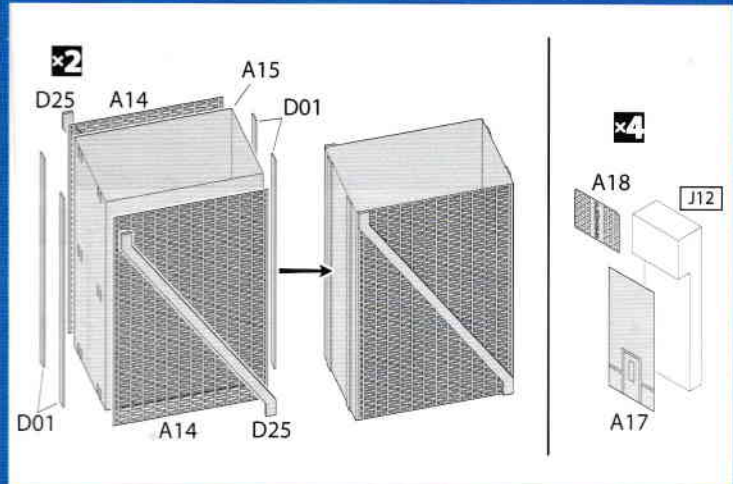
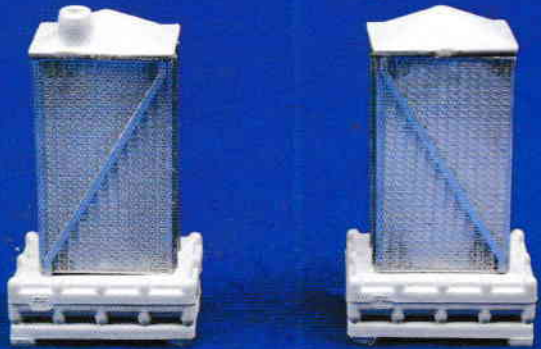

35



A12(A12)

36



D35

A08

C12

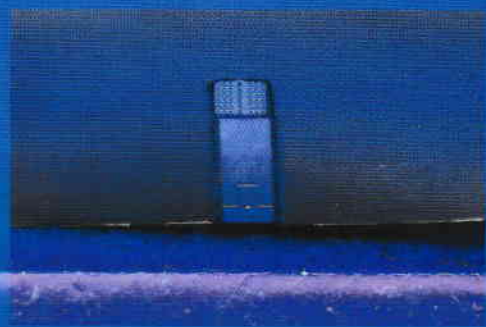

38



A07(A07)

B09(B08)

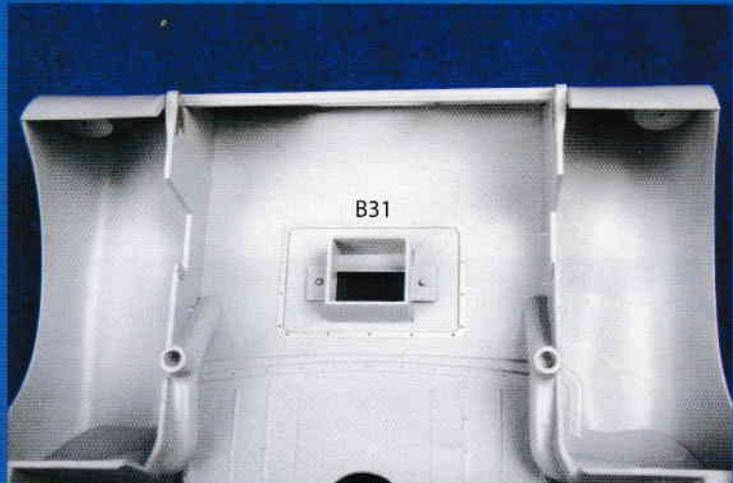

B31

39



B34

E01

41



WM03

WM02





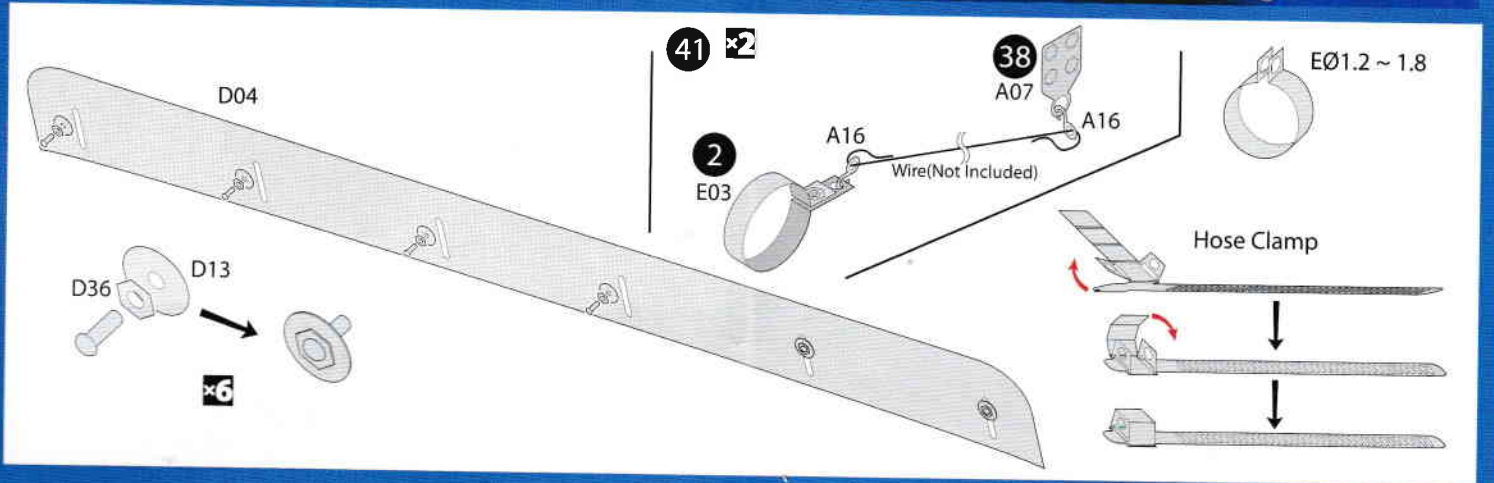
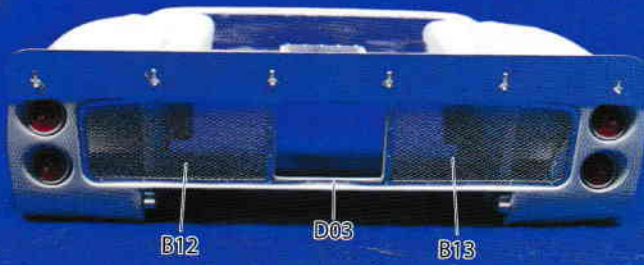



WM04

40



GT-40 Mk-II

Turning Process Parts.

 Muffler 2ea.	 Steering Wheel Hub A 1ea.	 Steering Wheel Hub B 1ea.	 Toggle Switch 7ea.	 Pull Switch 3ea.
	 Shift Lever 1ea.	 Square Head Bolt 25ea.	 Round Head Bolt 18ea.	 Button 5ea.

White Metal Parts.

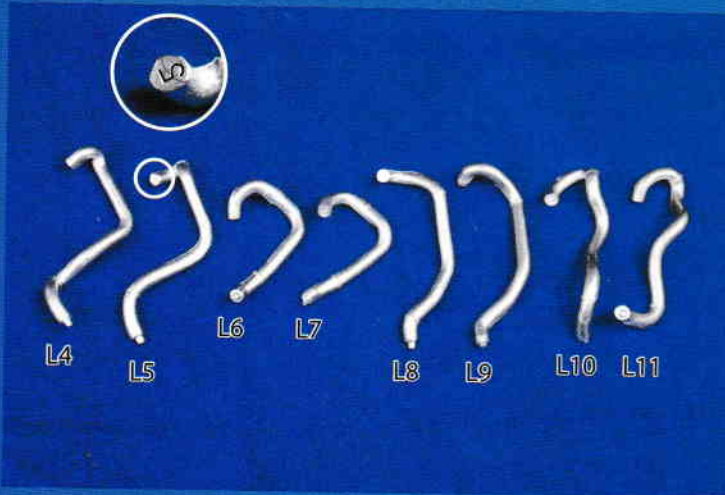

1/12 GT-40 Mk-II
Super Detail-up Parts Set.

