

式拾分の一

# 赤べこ

# 本家 2007



第六戦 磨納哥仕様 

## ASSEMBLY INSTRUCTIONS

### PARTS LIST

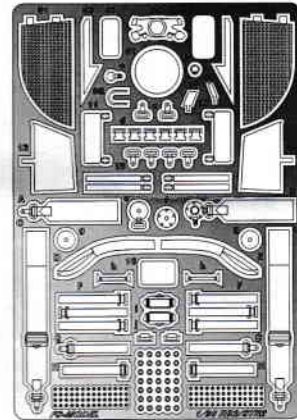
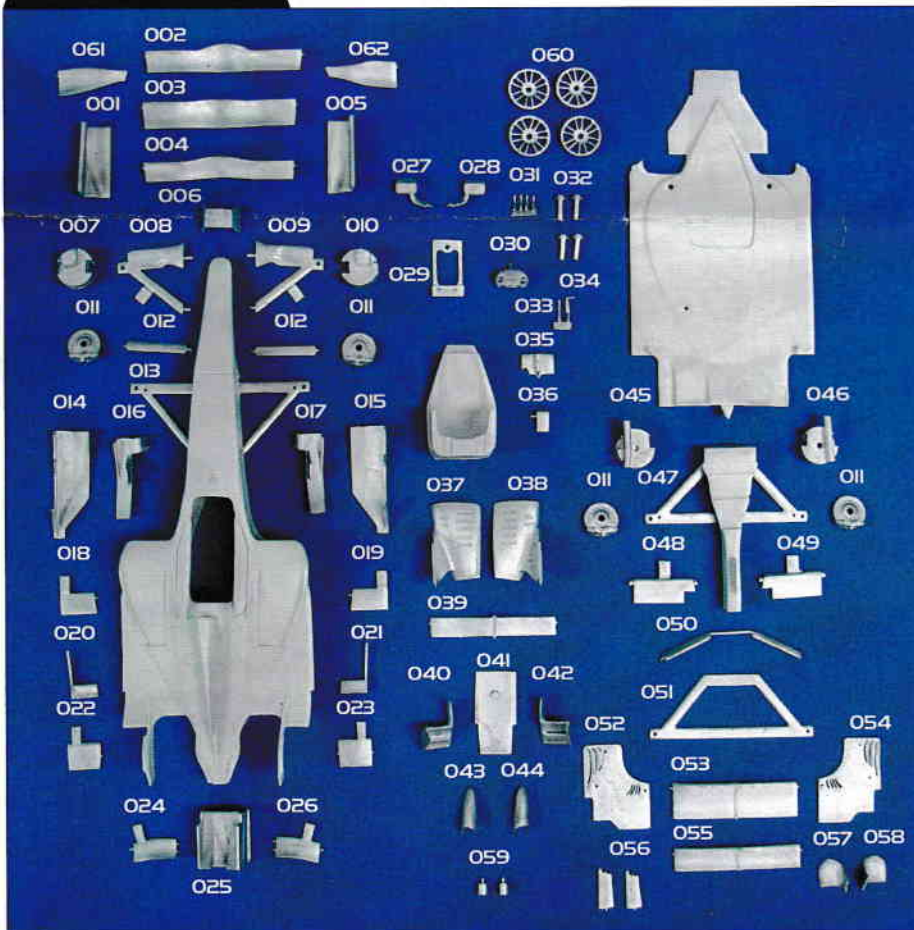

FRONT TYRE	X 2
F - WHEEL RIM	X 2
REAR TYRE	X 2
R - WHEEL RIM	X 2
ETCHING PARTS	X 1
CLEAR PARTS	X 1
MINISCREW	X 8
SCREW	X 5

### COLOR GUIDE



Dark metallic  
Blue



Semi gloss  
Black



Metallic gray



Yellow



Silver



Gold

● FRONT SECTION ASSEMBLY ●

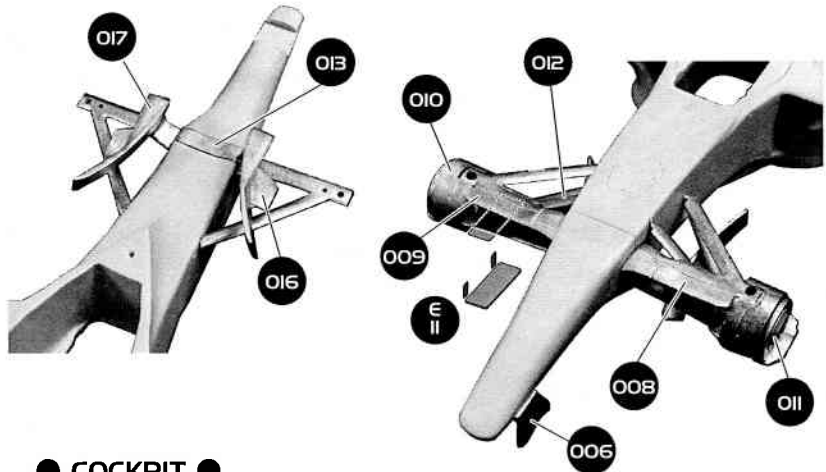
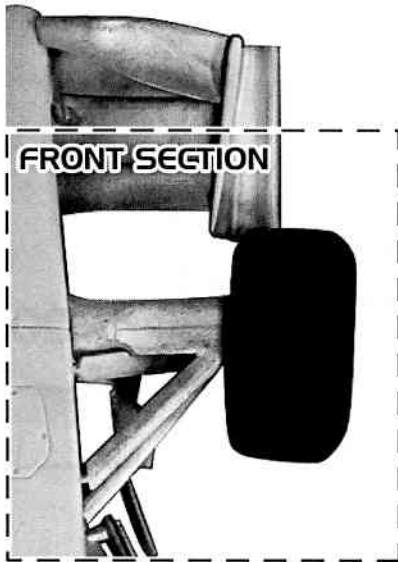

● COCKPIT ●

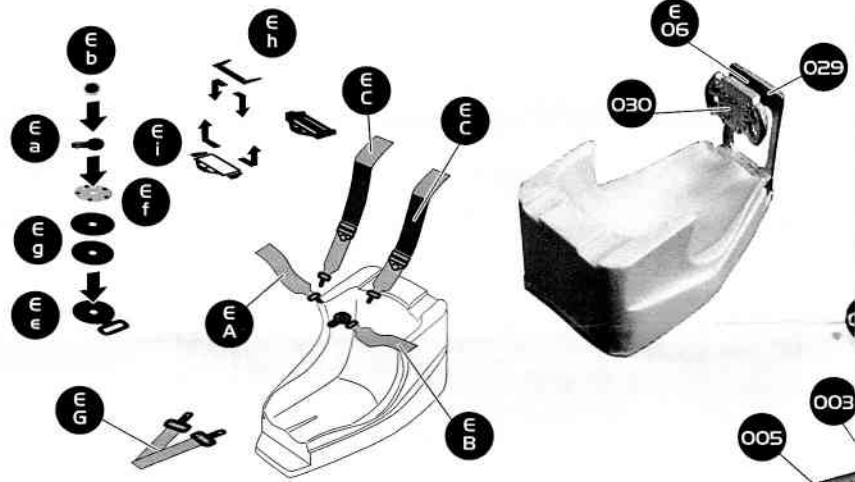

● REAR SECTION ASSEMBLY ●

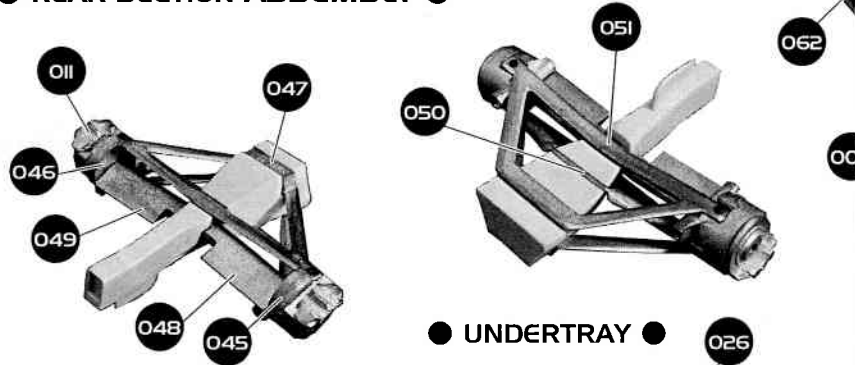
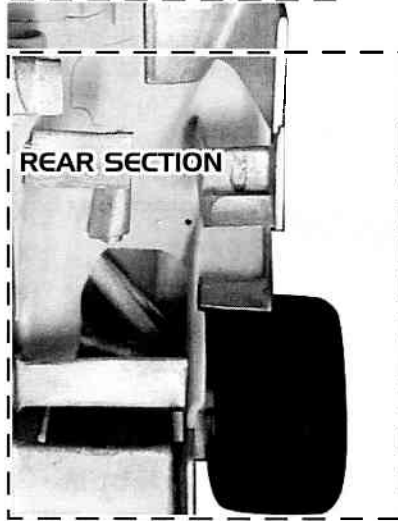

● UNDERTRAY ●

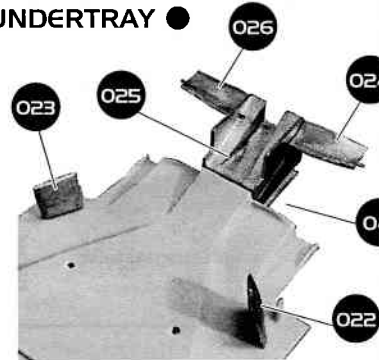
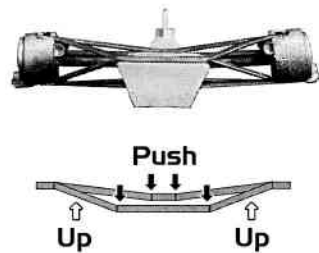
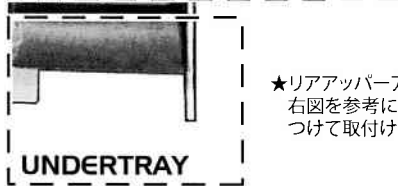

★リアアッパーアームは  
右図を参考に角度を  
つけて取付けて下さい。

● BODY PARTS ASSEMBLY ●

● REAR WING ASSEMBLY ●

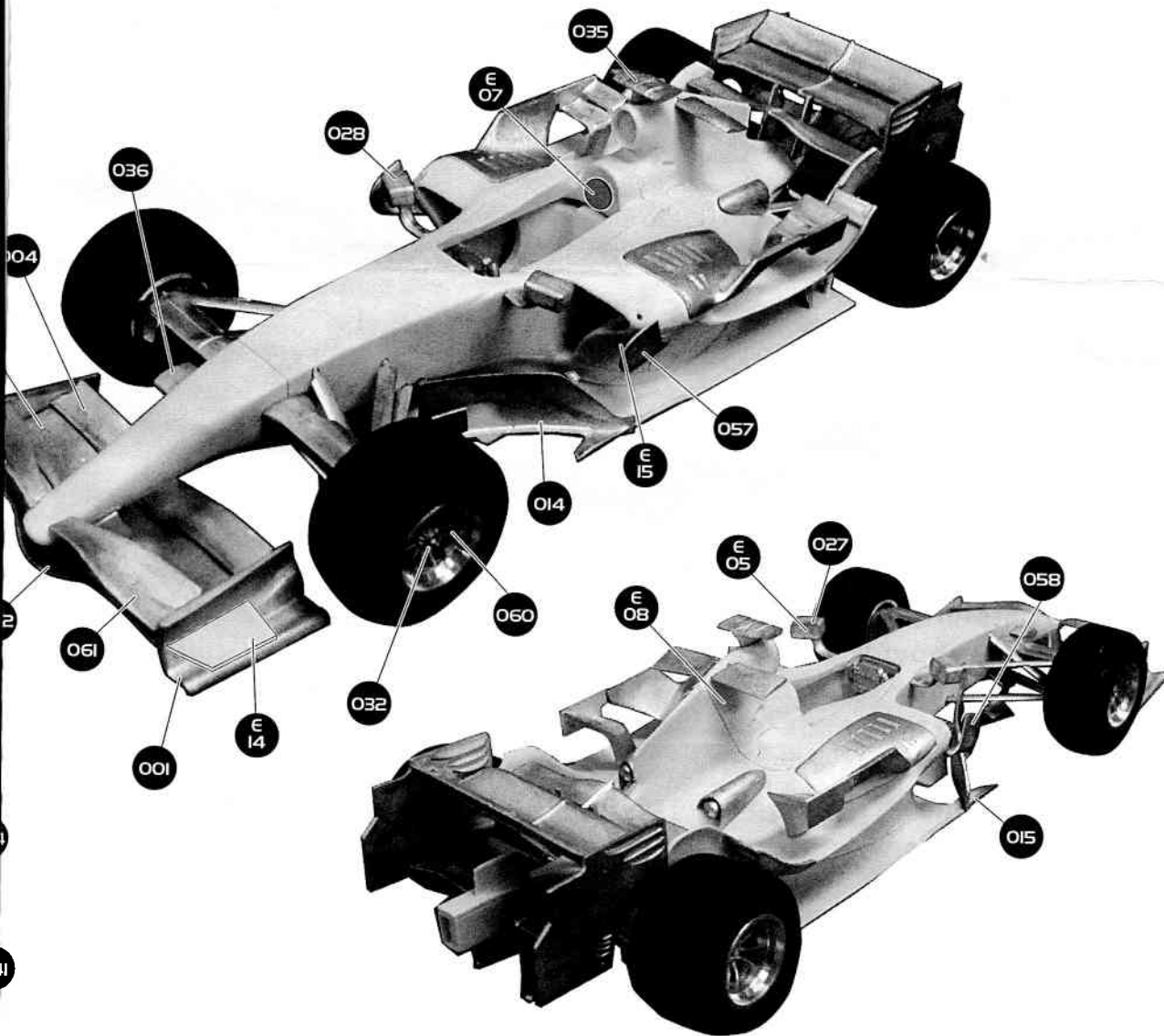
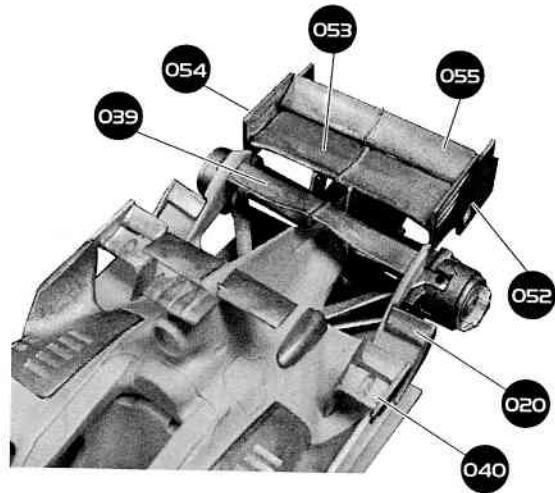
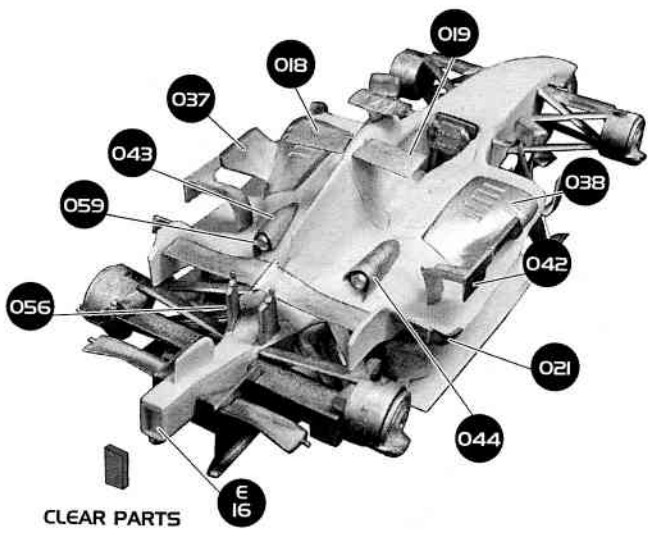

※ボディ等 各部の塗装は裏面図を参考にして下さい。

# GUIDE

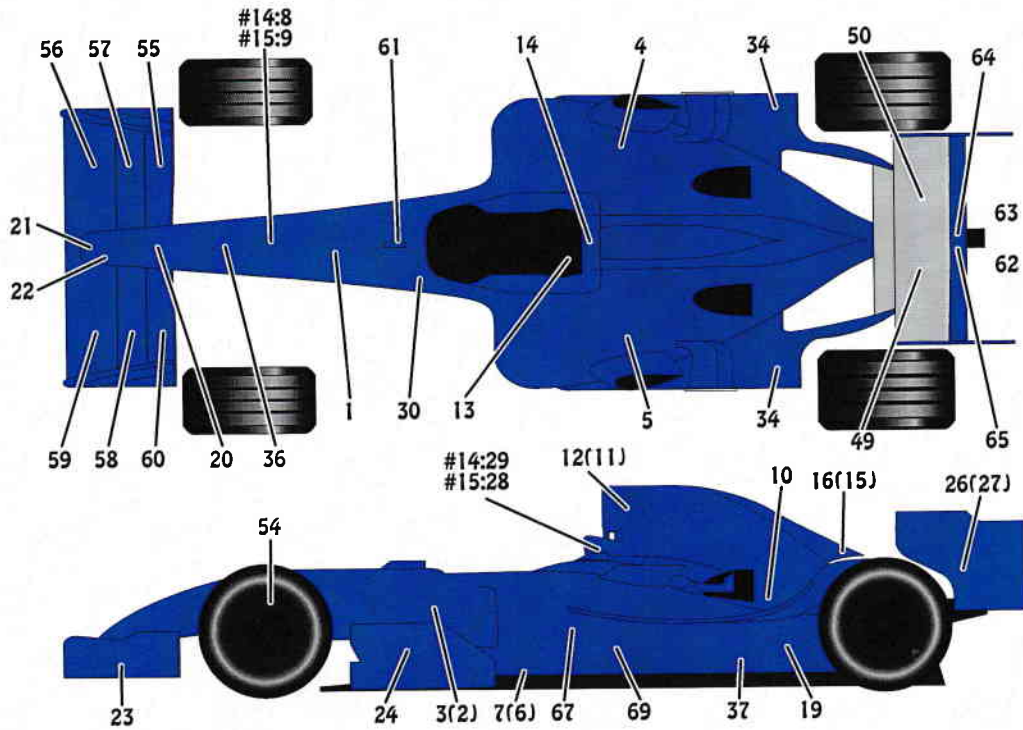

※ )内は反対側です。



## CAUTION

- Read carefully and fully understand all instructions before assembly.
- Extra care should be taken when using tools to avoid personal injury.
- Read and follow the instructions supplied with paint and/or cement. (not included)
- Use epoxy or CA glue only.
- Assemble the kit away from the reach of children.
- Model car for collectors. Not suitable for under 18 years old.